

## GEM SHOW SPECIAL ORDER FORM

<b>SHOW:</b> <b>The Green Living Show 2012</b>	<table border="1" style="width: 100%; border-collapse: collapse;"> <tr> <td style="width: 50%; padding: 5px;"><b>DISCOUNT PRICE DEADLINE DATE:</b></td> <td style="width: 50%; padding: 5px; text-align: center;"><b>March 26, 2012</b></td> </tr> </table>	<b>DISCOUNT PRICE DEADLINE DATE:</b>	<b>March 26, 2012</b>										
<b>DISCOUNT PRICE DEADLINE DATE:</b>	<b>March 26, 2012</b>												
<b>EXHIBITOR INFORMATION</b>													
<b>BOOTH #:</b> _____													
<b>COMPANY</b> _____													
<b>STREET</b> _____													
<b>CITY</b> _____ <b>PROV/STATE</b> _____ <b>CODE</b> _____													
<b>E-MAIL</b> _____													
<b>PHONE</b> _____ <b>FAX</b> _____													
<b>CONTACT NAME</b> _____													
<b>CREDIT CARD AUTHORIZATION</b>													
<input type="checkbox"/> MASTERCARD <input type="checkbox"/> VISA <input type="checkbox"/> AMEX													
<table border="1" style="width: 100%; border-collapse: collapse; text-align: center;"> <tr> <td style="width: 25px;"> </td><td style="width: 25px;"> </td><td style="width: 25px;"> </td><td style="width: 25px;"> </td> <td style="width: 25px;"> </td><td style="width: 25px;"> </td><td style="width: 25px;"> </td><td style="width: 25px;"> </td> <td style="width: 25px;"> </td><td style="width: 25px;"> </td><td style="width: 25px;"> </td><td style="width: 25px;"> </td> </tr> </table>													
<b>EXPIRY DATE</b> _____ / _____													
<b>CARDHOLDER NAME</b> _____													
<b>CARDHOLDER SIGNATURE</b> _____													
<input type="checkbox"/> CHEQUE ATTACHED (PAYABLE TO GES CANADA)													

# Show Special

→ Spend less    → Sell More    → Look great

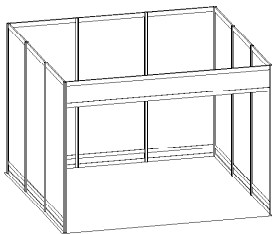

\$1,054.00

**PACKAGE A: 10'x10' BOOTH**

- Header Sign - 12"x116"
- Infill Panels
- Colour Coordinated 10'x10' Carpet
- Price after Deadline Date: **\$1,475.00**

- ✓ Installed and Dismantled
- ✓ Ready before you arrive
- ✓ No Labour Costs
- ✓ No Trucking Costs
- ✓ No Material Handling Costs
- ✓ Includes Carpet
- ✓ Includes Header Sign(s)
- ✓ Choice of Colours
- ✓ Accessories Available

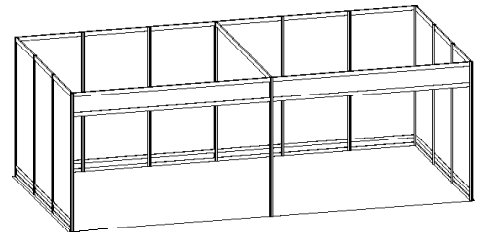

\$1,570.00

**PACKAGE B: 10'x20' BOOTH**

- 2 Header Signs - 12"x116" each
- Infill Panels
- Colour Coordinated 10'x20' Carpet
- Price after Deadline Date: **\$2,213.00**

Indicate Date and Time you plan to arrive to merchandise your exhibit: \_\_\_\_\_

Date

Time

<b>PLEASE COMPLETE THE FOLLOWING:</b>						
<b>SIZE ORDERED:</b>	<b>PACKAGE A:</b>	<input type="checkbox"/> 10'x10'	<b>PACKAGE B:</b>	<input type="checkbox"/> 10'x20'		
Infill Panel Colour:	<input type="checkbox"/> Black	<input type="checkbox"/> Blue	<input type="checkbox"/> Red	<input type="checkbox"/> Grey	<input type="checkbox"/> Forest Green	<input type="checkbox"/> Burgundy <input type="checkbox"/> White
Carpet Colour:	<input type="checkbox"/> Black	<input type="checkbox"/> Blue	<input type="checkbox"/> Red	<input type="checkbox"/> Grey	<input type="checkbox"/> Hunter Green	
<i>(All panel &amp; carpet colours subject to availability.)</i>						
Package A Identification Sign to Read: _____						
Package B Identification Sign to Read: Left: _____ Right: _____						
<input type="checkbox"/> <b>Custom Header to be added</b>						
Please e-mail artwork to: <a href="mailto:torontographics@ges.com">torontographics@ges.com</a> Label e-mail with Exhibitor Name & Show Name/Date (file must be eps, ai, cdr)						
Custom Header Signs/Logos will be charged \$100.00 extra per sign						
ALL ORDERS MUST BE PREPAID IN FULL (ORDERS CAN NOT BE PROCESSED UNTIL PAYMENT IS RECEIVED)						

**Terms & Conditions**

- Does not include lighting or electrical service.
- No refunds/exchanges once show move-in begins.
- All claims or discrepancies must be settled prior to show closing.
- All orders received after the Discount Price Date will be processed at the Regular Price.
- GES is not responsible for exhibit materials left in GEM rental exhibits or counter storage units.

SUBTOTAL	
13% HST	
TOTAL	
	HST #R104060264

**I have read and understand the Terms & Conditions of my Agreement with GES.**

\_\_\_\_\_

Signature

\_\_\_\_\_

Date



# standard exhibit rentals

**10' X 10'**  
**EXHIBITS**

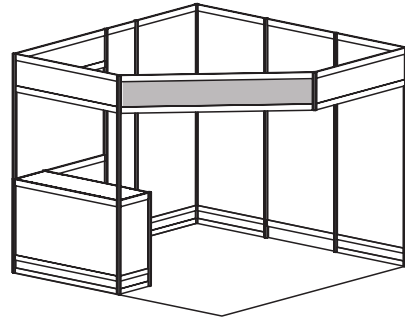

● GEM Model #1 - 10'x10' Corner

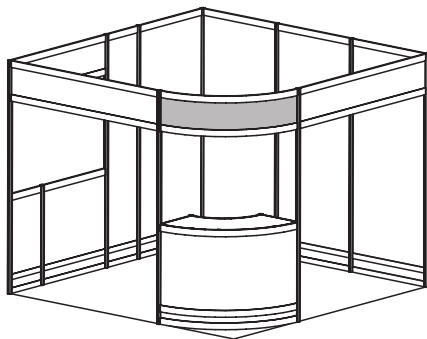

● GEM Model #2 - 10'x10' Corner

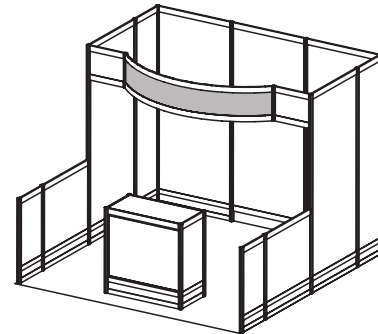

● GEM Model #3 - 10'x10'

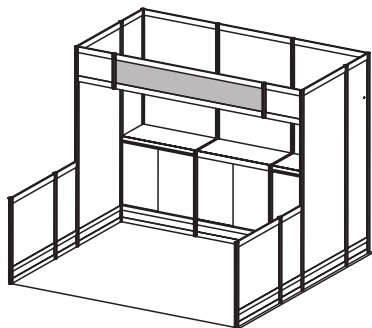

● GEM Model #4 - 10'x10'

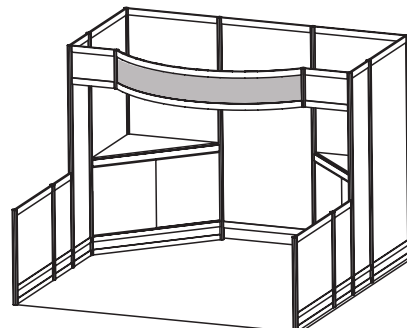

● GEM Model #5 - 10'x10'

## 3 Easy Steps →

- 1 Select the model number that suits your needs
- 2 Choose carpet and panel colours on the GEM Exhibit Rental order form
- 3 Complete & send order form

Grey indicates standard header sign(s)



# standard exhibit rentals

**10' X 20'**  
**EXHIBITS**

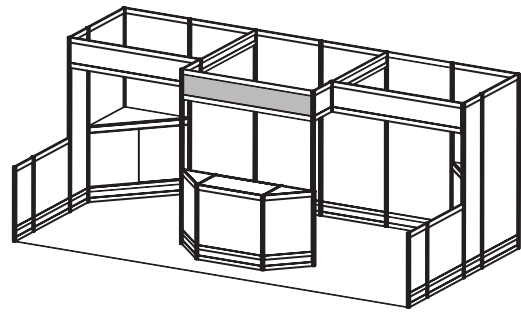

● GEM Model #6 - 10'x20'

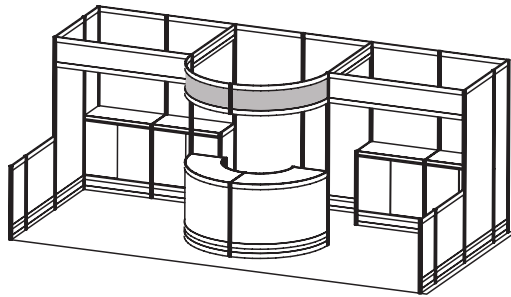

● GEM Model #7 - 10'x20'

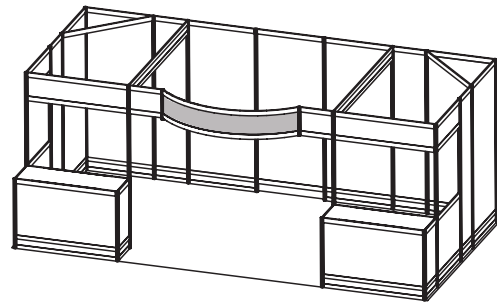

● GEM Model #8 - 10'x20'

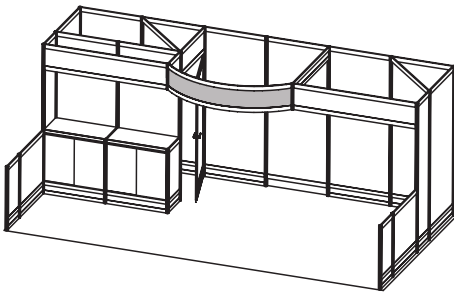

● GEM Model #9 - 10'x20'

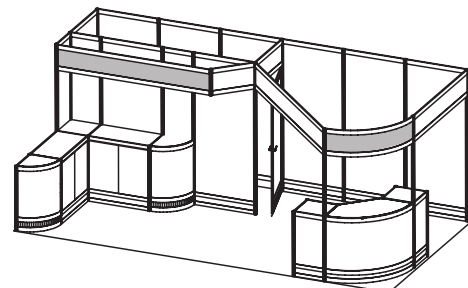

● GEM Model #10 - 10'x20' Corner

## 3 Easy Steps

- 1 Select the model number that suits your needs
- 2 Choose carpet and panel colours on the GEM Exhibit Rental order form
- 3 Complete & send order form

Grey indicates standard header sign(s)

5675 McLaughlin Road, Mississauga, Ontario, L5R 3K5 Tel: 905-283-0500 Fax: 905-283-0501 Toll Free: 1-877-437-4247 www.gesexpo.ca

<b>SHOW:</b> <b>The Green Living Show 2012</b>	<table border="1" style="width:100%; border-collapse: collapse;"> <tr> <td style="width:50%; padding: 5px;"><b>DISCOUNT PRICE DEADLINE DATE:</b></td> <td style="width:50%; padding: 5px;"><b>March 26, 2012</b></td> </tr> </table>	<b>DISCOUNT PRICE DEADLINE DATE:</b>	<b>March 26, 2012</b>		
<b>DISCOUNT PRICE DEADLINE DATE:</b>	<b>March 26, 2012</b>				
<b>EXHIBITOR INFORMATION</b>	<b>CREDIT CARD AUTHORIZATION</b>				
<b>BOOTH #:</b> _____ COMPANY _____ STREET _____ CITY _____ PROV/STATE _____ CODE _____ E-MAIL _____ PHONE _____ FAX _____ CONTACT NAME _____	<input type="checkbox"/> MASTERCARD <input type="checkbox"/> VISA <input type="checkbox"/> AMEX <table border="1" style="width:100%; height: 20px; border-collapse: collapse;"> <tr> <td style="width: 25%;"></td> <td style="width: 25%;"></td> <td style="width: 25%;"></td> <td style="width: 25%;"></td> </tr> </table> EXPIRY DATE _____ / _____ <hr/> CARDHOLDER NAME _____ <hr/> CARDHOLDER SIGNATURE _____ <input type="checkbox"/> CHEQUE ATTACHED (PAYABLE TO GES CANADA)				

**ALL ORDERS MUST BE PREPAID IN FULL  
(ORDERS CANNOT BE PROCESSED UNTIL PAYMENT IS RECEIVED)**

Model Number	Discount Price	Regular Price	Model Number	Discount Price	Regular Price
<b>Model #1</b>	\$1,608.00	\$2,250.00	<b>Model #6</b>	\$3,400.00	\$4,760.00
<b>Model #2</b>	\$1,425.00	\$1,995.00	<b>Model #7</b>	\$3,519.00	\$4,925.00
<b>Model #3</b>	\$1,698.00	\$2,376.00	<b>Model #8</b>	\$3,279.00	\$4,588.00
<b>Model #4</b>	\$1,853.00	\$2,593.00	<b>Model #9</b>	\$3,450.00	\$4,828.00
<b>Model #5</b>	\$1,889.00	\$2,643.00	<b>Model #10</b>	\$3,875.00	\$5,423.00

**Package Includes:** Installation & Dismantling, Choice of Carpet Colour, Choice of Panel Colour, Company Identification Sign

**Package Does Not Include:** Cleaning, Light Fixtures or Electrical Outlets

**PLEASE COMPLETE THE FOLLOWING:**    MODEL NUMBER:     *Upgrade options available. Contact Exhibitor Services.*

Font Colour:     Black

Infill Panel Colour:     Black Fabric     Blue Fabric     Grey Fabric     White Hardwall    *(Fabric Panels are velcro compatible)*

Carpet Colour:     Black     Blue     Grey     Red    *(All panel & carpet colours subject to availability.)*

Models 1, 2, 3, 4, 5, 6, 8 or 9 Identification Sign to Read: \_\_\_\_\_

Models 7 or 10 Identification Sign to Read:    Left: \_\_\_\_\_    Right: \_\_\_\_\_

Indicate Date & Time for Arrival: \_\_\_\_\_

**Custom Header Signs/Logos will be charged \$100.00 extra per sign**

**ALL ORDERS MUST BE PREPAID IN FULL  
(ORDERS CANNOT BE PROCESSED UNTIL PAYMENT IS RECEIVED)**

**Terms & Conditions**

- Payment may be made by cheque up to two weeks prior to the 1<sup>st</sup> day of move in.
- All orders received after the Discount Price Date will be processed at the Regular Price.
- Exhibitor is responsible for all items for the duration of the show.
- Charges are for rental of equipment only. All items remain the property of GES.
- No refunds/exchanges once show move-in begins. All claims or discrepancies must be settled prior to show closing.
- GES is not responsible for exhibit materials left in GEM rental exhibits or counter storage units.

<b>SUBTOTAL</b>	
<b>13% HST</b>	
<b>TOTAL</b>	
	HST #R104060264

**I have read and understand the Terms & Conditions of my Agreement with GES.**

\_\_\_\_\_  
Signature

\_\_\_\_\_  
Date

# GEM EXHIBIT ACCESSORIES ORDER FORM

SHOW: **The Green Living Show 2012**

**EXHIBITOR INFORMATION**

BOOTH #: \_\_\_\_\_

COMPANY \_\_\_\_\_

STREET \_\_\_\_\_

CITY \_\_\_\_\_ PROV/STATE \_\_\_\_\_ CODE \_\_\_\_\_

E-MAIL \_\_\_\_\_

PHONE \_\_\_\_\_ FAX \_\_\_\_\_

CONTACT NAME \_\_\_\_\_

**DISCOUNT PRICE DEADLINE DATE:** **March 26, 2012**

**CREDIT CARD AUTHORIZATION**

MASTERCARD  VISA  AMEX

\_\_\_\_\_|\_\_\_\_\_|\_\_\_\_\_|\_\_\_\_\_|\_\_\_\_\_|\_\_\_\_\_|\_\_\_\_\_|\_\_\_\_\_|

EXPIRY DATE \_\_\_\_/\_\_\_\_/\_\_\_\_

CARDHOLDER NAME \_\_\_\_\_

CARDHOLDER SIGNATURE \_\_\_\_\_

CHEQUE ATTACHED (PAYABLE TO GES CANADA)

**ALL ORDERS MUST BE PREPAID IN FULL**  
 (ORDERS CAN NOT BE PROCESSED UNTIL PAYMENT IS RECEIVED) LIGHTS ARE INCLUDED IN SHOWCASES (ELECTRICAL SERVICES EXTRA)

QTY	#	DESCRIPTION	DISCOUNT PRICE	REGULAR PRICE	TOTAL
	1	Pedestal (White) 20"L x 20"W □ 28"H or □ 36"H	\$117.00	\$163.00	
	2	Pedestal White 40"L X 40"W (Tops are 20" X 20") (Unit Heights - 16"- 28" & 28"- 41")	\$424.00	\$593.00	
	3	Storage Counter (White) 80"L X 20"W X 41"H	\$354.00	\$495.00	
	4	Curved Counter (White) 60"L X 20"W X 36"H	\$289.00	\$404.00	
	5	99A Showcase (White/Glass) 40"L X 20"W X 41"H	\$289.00	\$404.00	
	6	99B Showcase (White/Glass) 40"L X 20"W X 41"H	\$289.00	\$404.00	
	7	99C Showcase (White/Glass) 26"L X 26"W X 96"H	\$424.00	\$593.00	
	8	99D Showcase (White/Glass) 40"L X 20"W X 96"H	\$424.00	\$593.00	

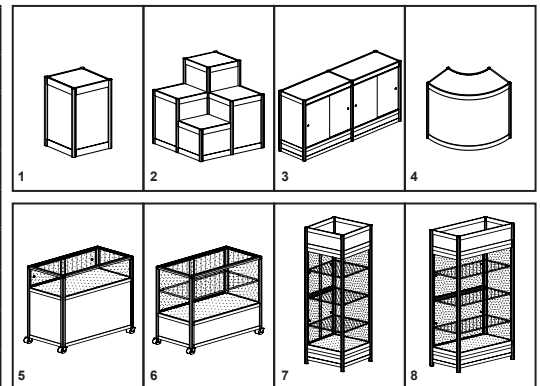

QTY	#	DESCRIPTION	DISCOUNT PRICE	REGULAR PRICE	TOTAL
	A	Waterfall With Eight Balls	\$35.00	\$49.00	
	B	Grid Panels - 38"W X 44"H White Panels (2" Squares)	\$117.00	\$163.00	
	C	Garment Rail 39"W	\$42.00	\$58.00	
	D	Shelves □ Flat □ Angled 37"L X 12"W	\$37.00	\$52.00	
	E	Slatwall Panels - 37"W X 96"H Grey (Upgrade for standard panels)	\$99.00	\$138.00	

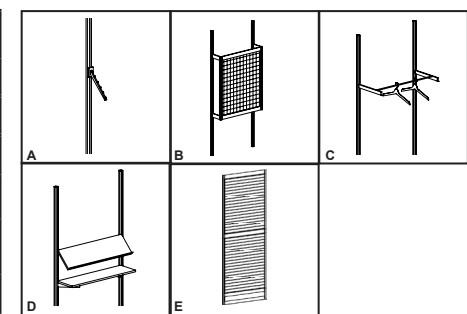

To Be Able To Rent These Accessories, You Must Order a GEM Hardwall Booth From GES.

Please Attach Diagram Of Booth Indicating Locations For Grid Panels And/Or Slatwall. Grid Panels Cannot Be Installed In Corners.

**Terms & Conditions**

- All items subject to availability.
- No refunds/exchanges once show move-in begins.
- All claims or discrepancies must be settled prior to show closing.
- Exhibitor is responsible for all items for the duration of the show.
- Charges are for rental of equipment. All items remain the property of GES.
- All orders received after the Discount Price Date will be processed at the Regular Price.

<b>SUBTOTAL</b>	
<b>13% HST</b>	
<b>TOTAL</b>	
	HST #R104060264

I have read and understand the Terms & Conditions of my Agreement with GES.

\_\_\_\_\_  
Signature

\_\_\_\_\_  
Date